

DESCRIPTION

The MC34064 is an undervoltage sensing circuit designed specifically for use as a reset controller in microprocessor-based systems. It offers the designer an economical, space-efficient solution for low supply voltage detection when used in combination with a single pullup resistor. Adding one capacitor offers the functionality of a programmable delay time after power returns. The 34064 consists of a temperature stable reference comparator with hysteresis, high-current clamping diode and open

collector output stage capable of sinking up to 60mA. The MC34064's **RESET** output is specified to be fully functional at $V_{IN}=1V$. A major improvement over competing products is the glitch-free supply current during undervoltage detection. Competing products demand a step function increase in operating current during the time that you least want or need it: during power loss. See Product Highlight below.

IMPORTANT: For the most current data, consult *MICROSEMI*'s website: <http://www.microsemi.com>

KEY FEATURES

- Monitors 5V Supplies ($V_T = 4.6V$ Typ.)
- Outputs Fully Defined At $V_{IN} = 1V$ (See Figure 1)
- Glitch-Free Supply Current During Switching (See Product Highlight)
- Ultra-Low Supply Current (500 μA Max.)
- Temperature Compensated ICC For Extremely Stable Current Consumption
- μP Reset Function Programmable With 1 External Resistor And Capacitor
- Comparator Hysteresis Prevents Output Oscillation
- Electrically Compatible With Motorola MC34064
- Pin-to-Pin Compatible With Motorola MC34064 / MC34164

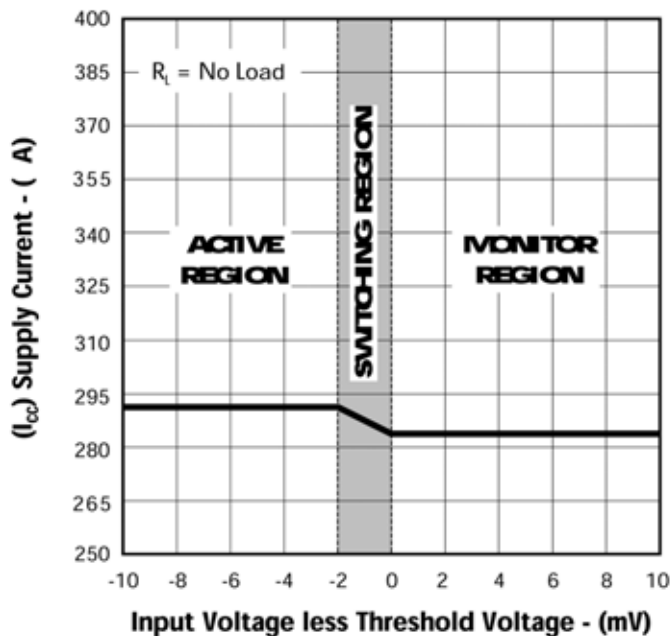
PRODUCT HIGHLIGHT
SUPPLY CURRENT VS. INPUT VOLTAGE

KEY FEATURES

- All Microprocessor Or Microcontroller Designs Using 5V Supplies
- Simple 5V Undervoltage Detection

PACKAGE ORDER INFO

T_A ($^{\circ}C$)	DM Plastic SOIC 8-Pin	LP Plastic TO-92 3-Pin	PK Plastic SOT-89 3-Pin
	RoHS / Pb-free Transition DC: 0440	RoHS / Pb-free Transition DC: 0509	RoHS / Pb-free Transition DC: 0518
0 to 70	MC34064DM	MC34064LP	MC34064PK
-40 to 85	MC33064DM	MC33064LP	MC33064PK

Note: Available in Tape & Reel. Append the letters "TR" to the part number. (i.e. MC34064DM-TR)

ABSOLUTE MAXIMUM RATINGS

Input Supply Voltage (V_{IN}).....	-1V to 10V
\overline{RESET} Output Voltage (V_{OUT}).....	10V
Output Sink Current (I_{OL})	Internally Limited (mA)
Clamp Diode Forward Current (I_F), Pin 1 to Pin 2.....	100mA
Operating Temperature Range	150°C
Storage Temperature Range.....	-65°C to 150°C
Package Peak Temp. for Solder Reflow (40 seconds maximum exposure) ...	260°C (+0 -5)

Note: Exceeding these ratings could cause damage to the device. All voltages are with respect to Ground. Currents are positive into, negative out of specified terminal.

THERMAL DATA
DM Plastic SOIC 8-Pin

THERMAL RESISTANCE-JUNCTION TO AMBIENT, θ_{JA}	165°C/W
---	---------

LP Plastic TO-92 3-Pin

THERMAL RESISTANCE-JUNCTION TO AMBIENT, θ_{JA}	156°C/W
---	---------

PK Plastic SOT-89 3-Pin

THERMAL RESISTANCE-JUNCTION TO TAB, θ_{JT}	35°C/W
THERMAL RESISTANCE-JUNCTION TO AMBIENT, θ_{JA}	71°C/W

Junction Temperature Calculation: $T_J = T_A + (P_D \times \theta_{JA})$.

The θ_{JA} numbers are guidelines for the thermal performance of the device/pc-board system. All of the above assume no ambient airflow.

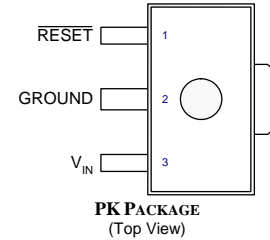
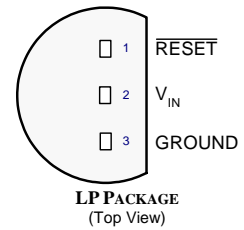
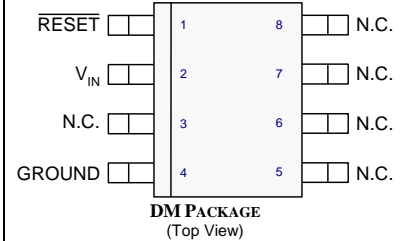
PACKAGE PIN OUT

RoHS / Pb-free 100% matte Tin Lead Finish

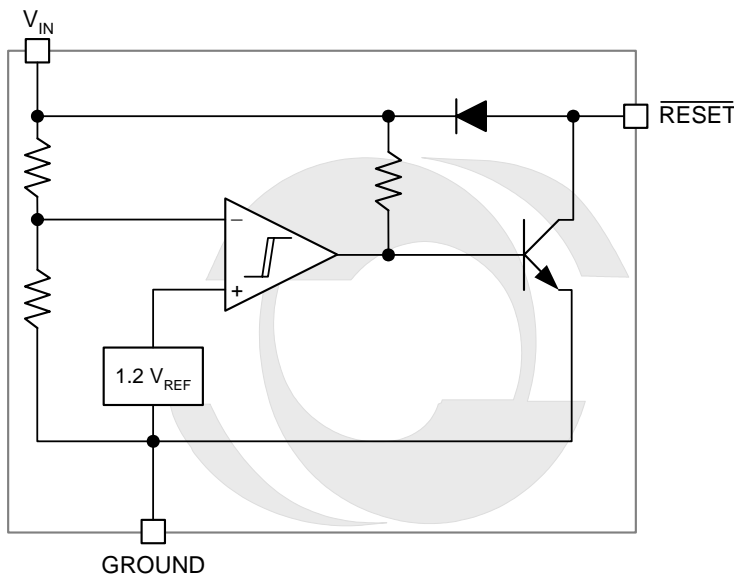
SIMPLIFIED BLOCK DIAGRAM

UNDervoltage Sensing Circuit

PRODUCTION DATA SHEET

RECOMMENDED OPERATING CONDITIONS (Note 2)

Parameter	Symbol	Recommended Operating Conditions			Units
		Min.	Typ.	Max.	
Input Supply Voltage	V_{IN}	1		6.5	V
RESET Output Voltage	V_{OUT}		6.5		V
Clamp Diode Forward Current	I_F		50mA		
Operating Ambient Temperature Range:					
MC34064	T_A	0		70	°C
MC33064	T_A	-40		85	°C

Note 2. Range over which the device is functional.

ELECTRICAL CHARACTERISTICS

(Unless otherwise specified, these specifications apply over the operating ambient temperatures of $0^\circ\text{C} = T_A = 70^\circ\text{C}$ for the MC34064 and $-40^\circ\text{C} = T_A = 85^\circ\text{C}$ for the MC33064. Low duty cycle pulse testing techniques are used which maintains junction and case temperatures equal to the ambient temperature.)

Parameter	Symbol	Test Conditions	MC34064/MC33064			Units
			Min.	Typ.	Max.	
Comparator Section						
Threshold Voltage						
High State Output	V_{T+}	V_{IN} Increasing — 4V to 5V	4.5	4.61	4.7	V
Low State Output	V_{T-}	V_{IN} Decreasing — 5V to 4V	4.5	4.59	4.7	V
Hysteresis	V_H		0.01	0.02	0.05	V
RESET Output Section						
Output Low Level Saturation Voltage	V_{OL}	$V_{IN} = 4.0V, I_{OL} = 8.0mA$			1.0	V
		$V_{IN} = 4.0V, I_{OL} = 2.0mA$			0.4	V
		$V_{IN} = 1.0V, I_{OL} = 0.1mA$			0.1	V
Output Low Level Current	I_{OL}	$V_{IN} = V_{OUT} = 4.0V$	10	27	60	mA
Output Off-State Leakage	I_{OH}	$V_{IN} = V_{OUT} = 5.0V$		0.02	0.5	μA
Clamp Diode Forward Voltage	V_F	Pin 1 to pin 2, $I_F = 10mA$	0.6	0.9	1.2	V
Total Device						
Supply Current	I_{CC}	$V_{IN} = 5.0V$		390	500	μA



GRAPH / CURVE INDEX

Characteristic Curves

FIGURE

1. INPUT VOLTAGE and $\overline{\text{RESET}}$ OUTPUT VOLTAGE vs. TIME
2. POWER-UP $\overline{\text{RESET}}$ VOLTAGE
3. POWER-DOWN $\overline{\text{RESET}}$ VOLTAGE
4. $\overline{\text{RESET}}$ OUTPUT VOLTAGE vs. INPUT VOLTAGE
5. THRESHOLD VOLTAGE vs. TEMPERATURE
6. THRESHOLD HYSTERESIS vs. TEMPERATURE
7. SUPPLY CURRENT vs. INPUT VOLTAGE
8. SUPPLY CURRENT vs. TEMPERATURE
9. LOW LEVEL OUTPUT CURRENT vs TEMPERATURE
10. LOW LEVEL OUTPUT SATURATION VOLTAGE vs. TEMPERATURE
11. LOW LEVEL OUTPUT SATURATION VOLTAGE vs. TEMPERATURE
12. CLAMP DIODE FORWARD VOLTAGE vs. FORWARD CURRENT
13. PROPAGATION DELAY — HIGH to LOW
14. PROPAGATION DELAY — LOW to HIGH

FIGURE INDEX

Application Circuits

FIGURE

15. LOW VOLTAGE MICROPROCESSOR RESET
16. SWITCHING THE LOAD OFF WHEN BATTERY REACHES BELOW 4.3V
17. VOLTAGE MONITOR
18. MOSFET LOW VOLTAGE GATE DRIVE PROTECTION
19. LOW VOLTAGE MICROPROCESSOR RESET with ADDITIONAL HYSTERESIS
20. SOLAR POWERED BATTERY CHARGER

UNDervoltage Sensing Circuit

PRODUCTION DATA SHEET

CHARACTERISTIC CURVES

FIGURE 1. — INPUT VOLTAGE and $\overline{\text{RESET}}$ OUTPUT VOLTAGE vs. TIME

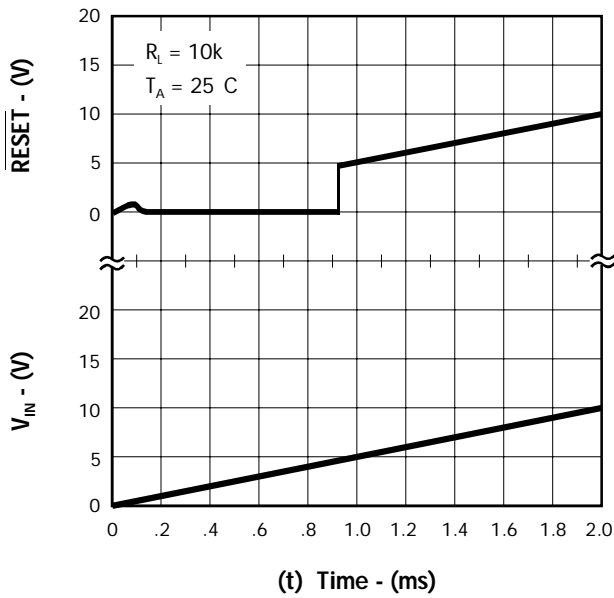

FIGURE 2. — POWER-UP $\overline{\text{RESET}}$ VOLTAGE

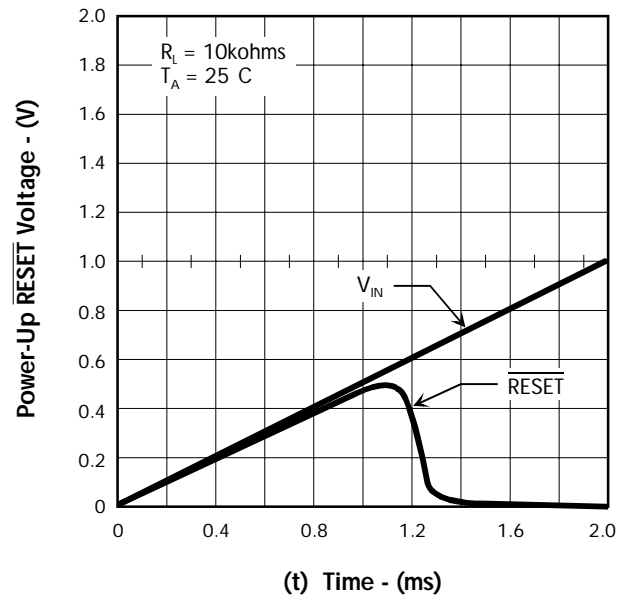

FIGURE 3. — POWER-DOWN $\overline{\text{RESET}}$ VOLTAGE

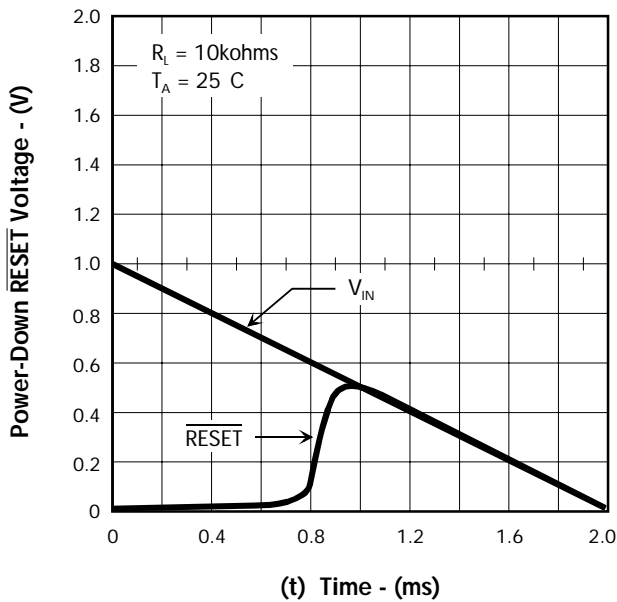
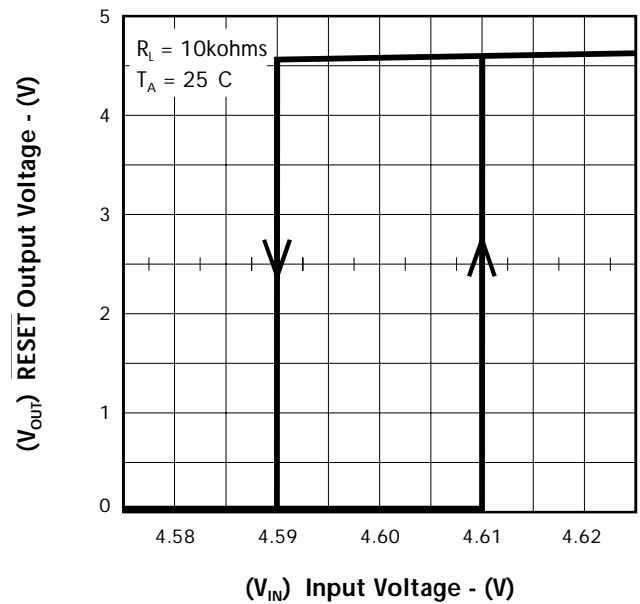

FIGURE 4. — $\overline{\text{RESET}}$ OUTPUT VOLTAGE vs. INPUT VOLTAGE



CHARACTERISTIC CURVES

FIGURE 5. — THRESHOLD VOLTAGE vs. TEMPERATURE

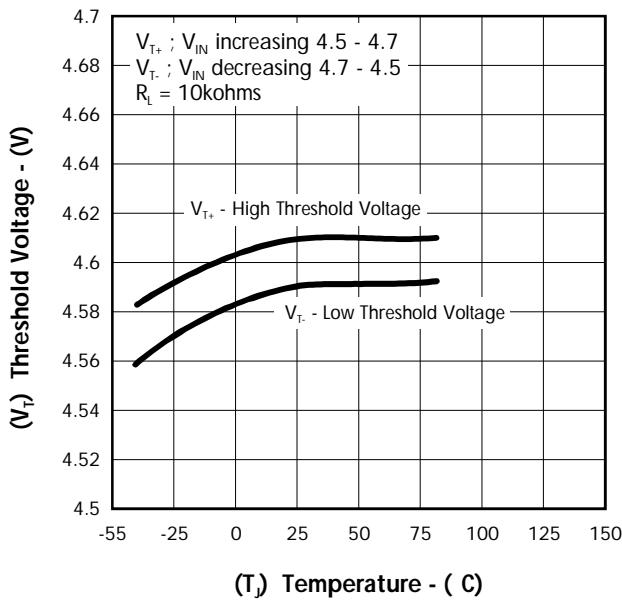

FIGURE 6. — THRESHOLD HYSTERESIS vs. TEMPERATURE

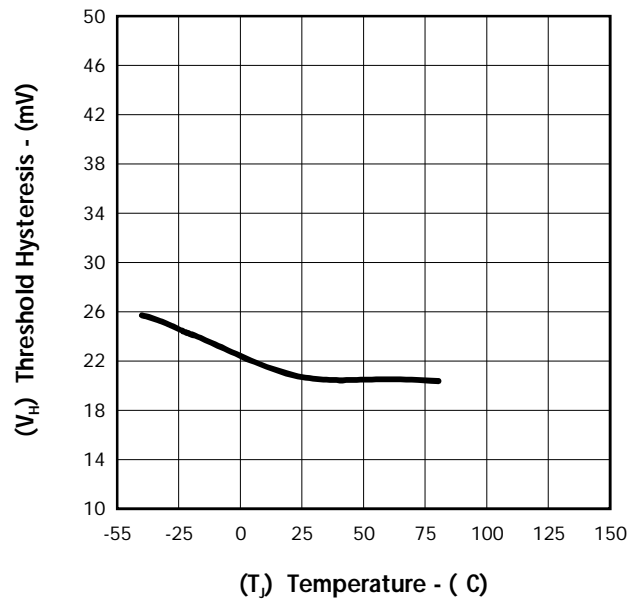

FIGURE 7. — SUPPLY CURRENT vs. INPUT VOLTAGE

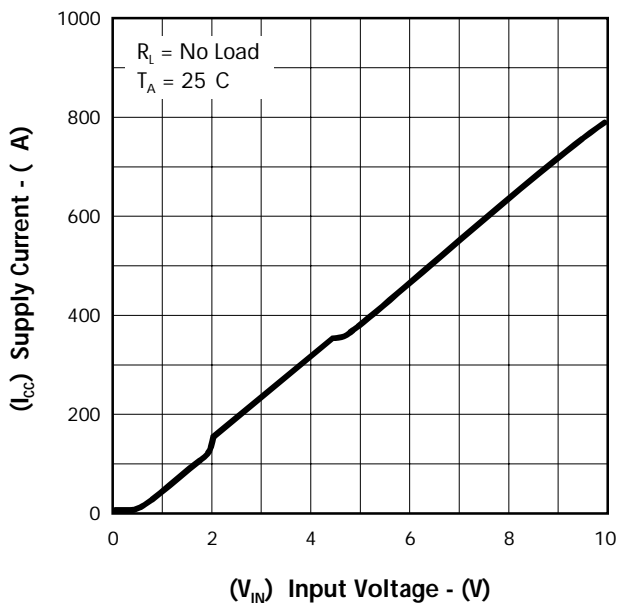
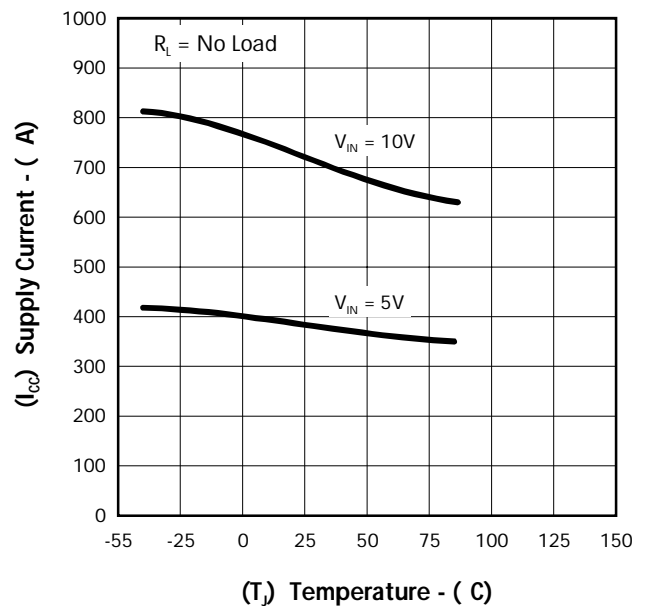

FIGURE 8. — SUPPLY CURRENT vs. TEMPERATURE



UNDervoltage Sensing Circuit

PRODUCTION DATA SHEET

CHARACTERISTIC CURVES

FIGURE 9. — LOW LEVEL OUTPUT CURRENT vs. TEMPERATURE

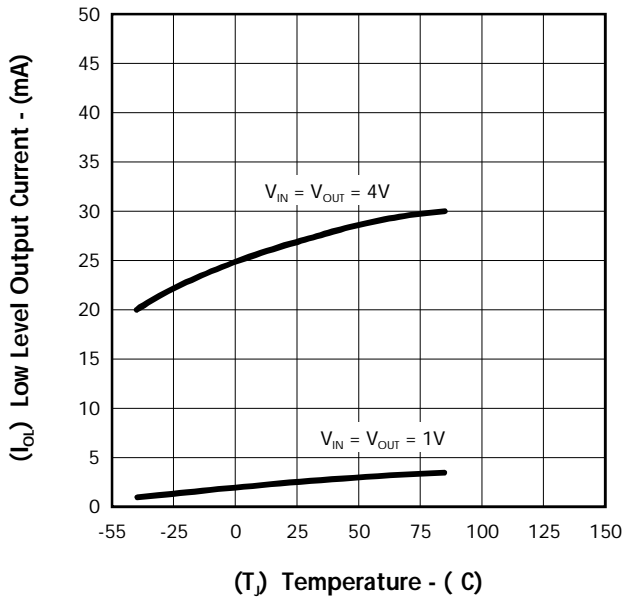

FIGURE 10. — LOW LEVEL OUTPUT SATURATION VOLTAGE vs. TEMPERATURE

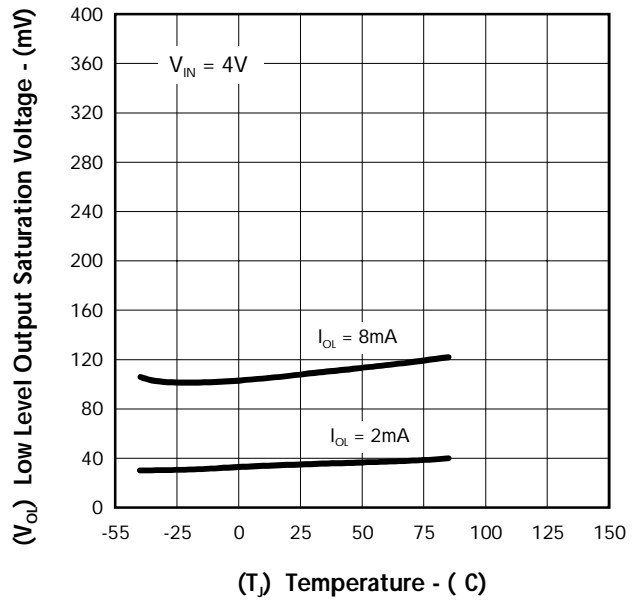

FIGURE 11. — LOW LEVEL OUTPUT SATURATION VOLTAGE vs. TEMPERATURE

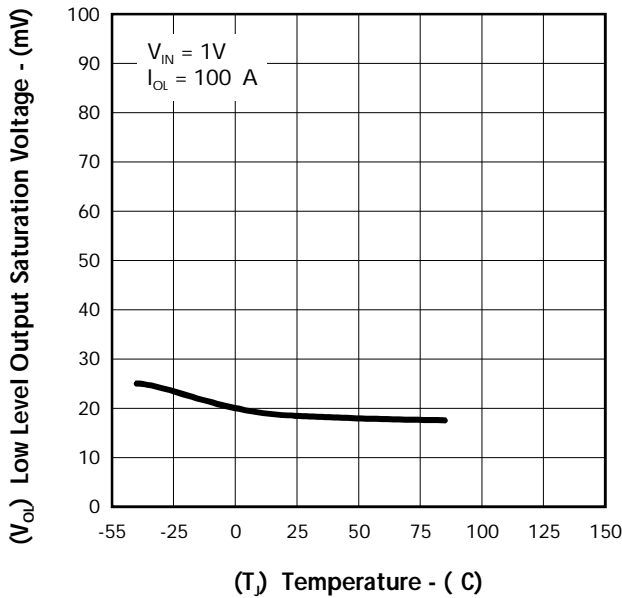
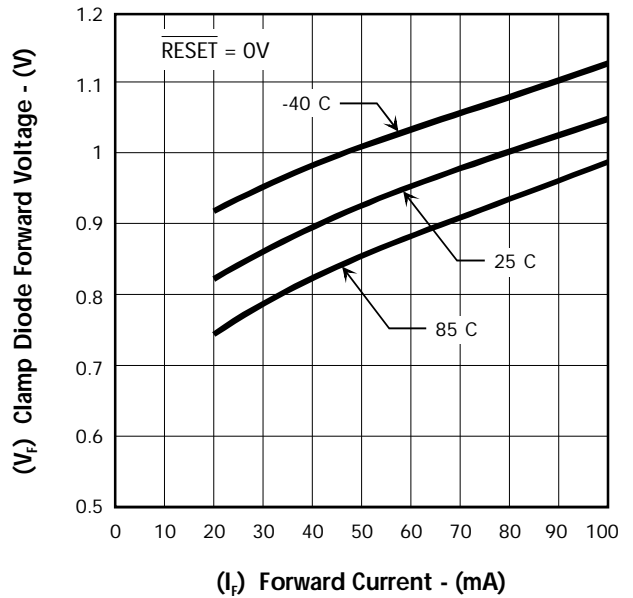

FIGURE 12. — CLAMP DIODE FORWARD VOLTAGE vs. FORWARD CURRENT



CHARACTERISTIC CURVES

FIGURE 13. — PROPAGATION DELAY — HIGH to LOW

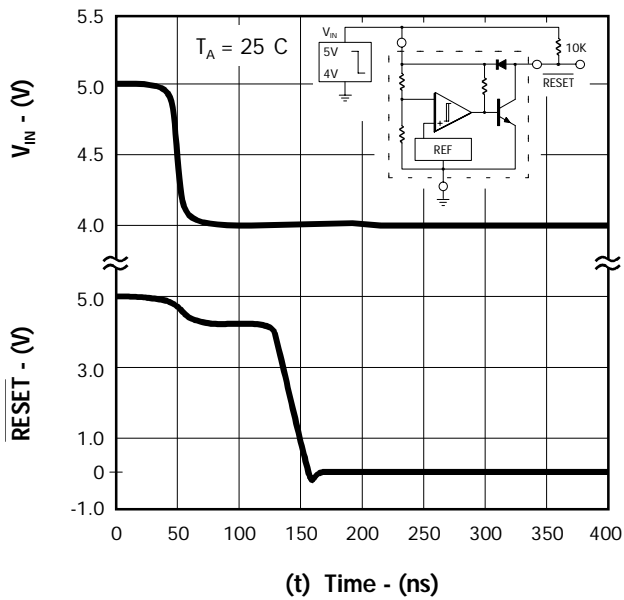
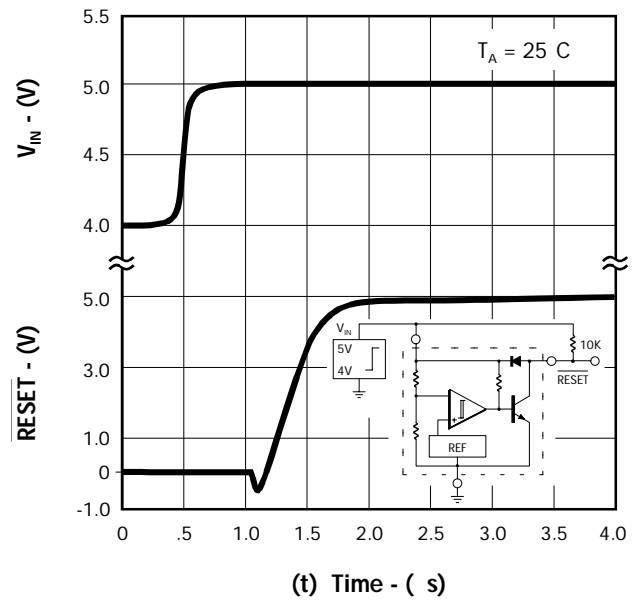

FIGURE 14. — PROPAGATION DELAY — LOW to HIGH



UNDervOLTAGE SENSING CIRCUIT

PRODUCTION DATA SHEET

TYPICAL APPLICATION CIRCUITS

FIGURE 15. — LOW VOLTAGE MICROPROCESSOR RESET

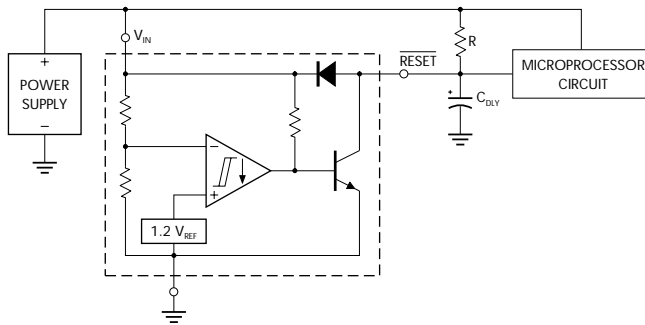

A time delayed reset can be accomplished with the addition of C_{DLY} . For systems with extremely fast power supply rise times ($< 500\text{ns}$) it is recommended that the RC_{DLY} time constant be greater than $5.0\mu\text{s}$. $V_{TH(MPU)}$ is the microprocessor reset input threshold.

$$t_{DLY} = R C_{DLY} \ln \left[\frac{1}{1 - \frac{V_{TH(MPU)}}{V_{IN}}} \right]$$

FIGURE 17. — VOLTAGE MONITOR

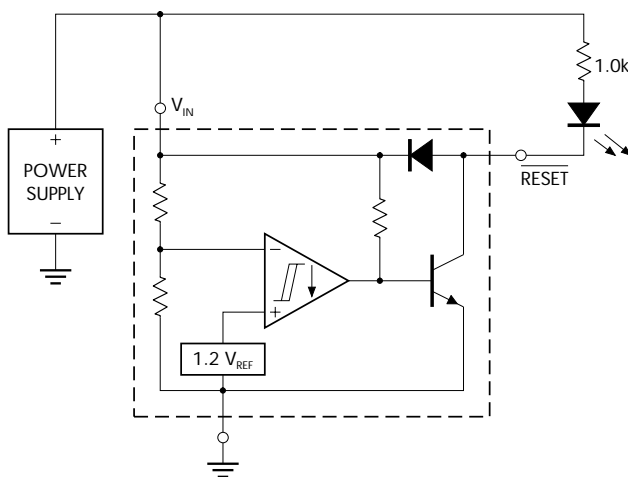

FIGURE 16. — SWITCHING THE LOAD OFF WHEN BATTERY REACHES BELOW 4.3V

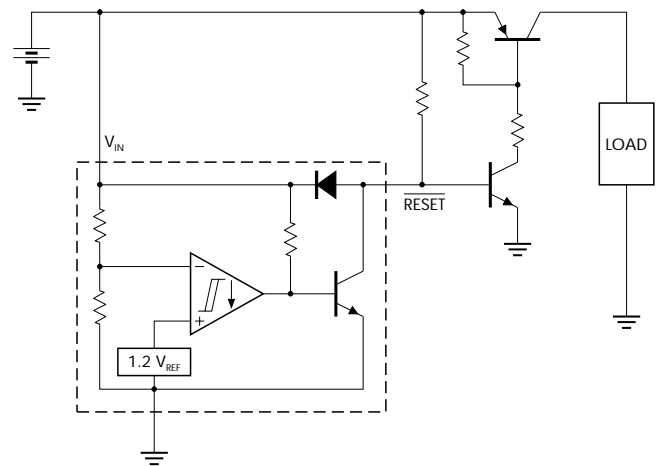
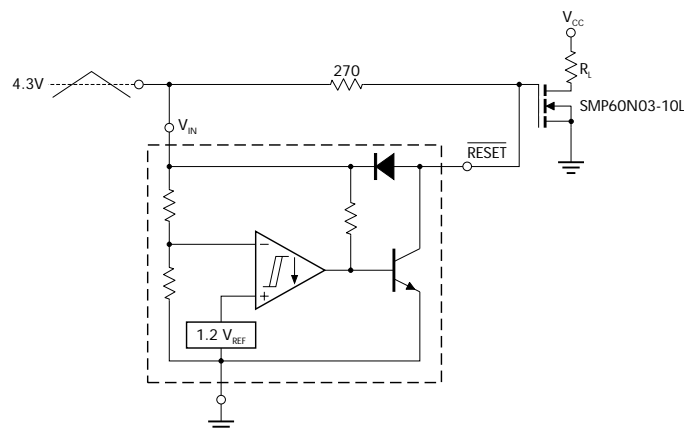

FIGURE 18. — MOSFET LOW VOLTAGE GATE DRIVE PROTECTION



Overheating of the logic level power MOSFET due to insufficient gate voltage can be prevented with the above circuit. When the input signal is below the 4.6 volt threshold of the MC34064, its output grounds the gate of the L² MOSFET.

TYPICAL APPLICATION CIRCUITS (Cont'd.)

FIGURE 19. — LOW VOLTAGE MICROPROCESSOR RESET with ADDITIONAL HYSTERESIS

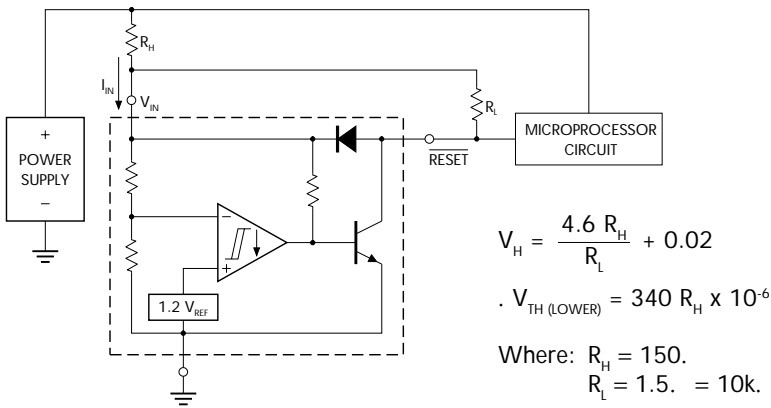

TEST DATA			
V_H (mV)	V_{TH} (mV)	R_H (.)	R_L (.)
20	0	0	0
51	3.4	10	1.5
40	6.8	20	4.7
81	6.8	20	1.5
71	10	30	2.7
112	10	30	1.5
100	16	47	2.7
164	16	47	1.5
190	34	100	2.7
327	34	100	1.5
276	51	150	2.7
480	51	150	1.5

Comparator hysteresis can be increased with the addition of resistor R_H . The hysteresis equation has been simplified and does not account for the change of input current I_{IN} as V_{CC} crosses the comparator threshold. An increase of the lower threshold $V_{TH(LOWER)}$ will be observed due to I_{IN} which is typically $340\mu A$ at $4.59V$. The equations are accurate to $\pm 10\%$ with R_H less than $150.$ and R_L between $1.5k.$ and $10k.$

FIGURE 20. — SOLAR POWERED BATTERY CHARGER

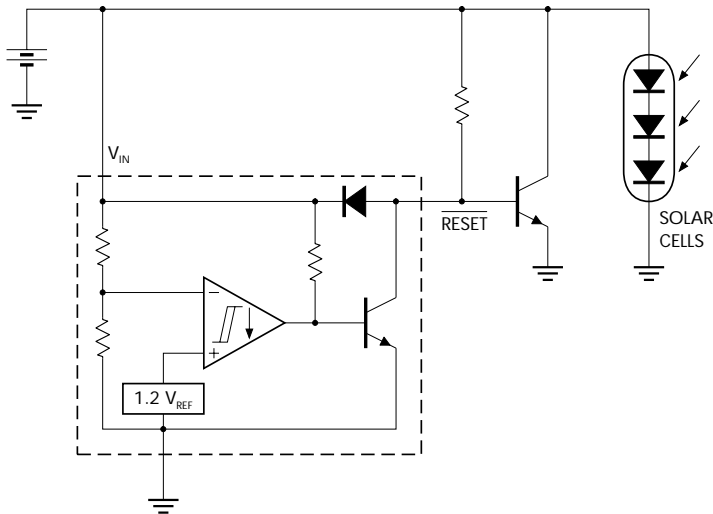

PRODUCTION DATA - Information contained in this document is proprietary to Linfinity, and is current as of publication date. This document may not be modified in any way without the express written consent of Linfinity. Product processing does not necessarily include testing of all parameters. Linfinity reserves the right to change the configuration and performance of the product and to discontinue product at any time.